

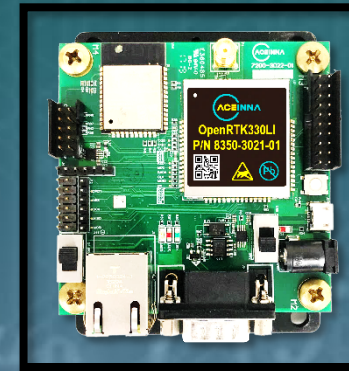

OpenRTK330 Evaluation Kit

User Guide



What You Need

Evaluation Kit includes:

- Evaluation Board
- Antenna
- Micro-USB cable
- Power adapter
- ST-Link Debugger

Additional equipment needed:

- Ethernet cable
- Ethernet router/switch or cellular modem

Software & Tools:

- Aceinna [developer's site](#) login
- OpenRTK [python driver](#)
- ST-Link Utility [software](#)
- OpenARC corrections [account](#)
- RTK Ntrip configuration



Before You Start

1. Download latest Aceinna Python Driver executable – [link](#)
2. Log in to Aceinna Navigation Studio – [link](#)
3. Create an OpenARC subscription or trial – [link](#)
 - a. OpenARC provides streaming GNSS corrections in US.
 - b. Standard NTRIP credentials may be used for other corrections streams.
4. Download and install ST-Link Utility – [link](#)
5. To use the Android app, download and install – [link](#)
 - a. <https://developers.aceinna.com/static/appDownload.html/>

USEFUL LINKS

- <https://openrtk.readthedocs.io/>
- <https://developers.aceinna.com/>
- <https://openarc.aceinna.com/>
- <http://openrtk/>
- <https://github.com/Aceinna/>
- <https://github.com/Aceinna/python-openimu/releases/>
- <https://www.st.com/en/development-tools/stsw-link004.html>

* Note: Google Chrome browser is preferred for best performance



Using the OpenRTK330 EVK Overview

HW & SW Setup Procedures

1. Evaluation Board Setup
 - a. HW connections
 - b. Data visualization on RTK monitor
 - c. Ethernet connectivity
 - d. RTK / NTRIP setup via Web GUI
 - e. Android mobile application
 - f. Data Logging & Parsing
2. Vehicle Installation
3. System Image Backup for recovery
4. Upgrading FW (for new firmware releases)

Evaluation & Testing Tools

- Developers environment

Additional Information

- Appendix 1 – Ethernet configuration
- Appendix 2 – Vehicle reference frames

QUICK REFERENCE

Evaluation Kit includes:

- Evaluation Board
- Antenna
- Micro-USB cable
- Power adapter
- ST-Link Debugger

Additional equipment required:

- Ethernet cable
- Ethernet router/switch or cellular modem

Software & Tools:

- Web-GUI configuration
- OpenRTK python driver
- OpenARC corrections account
- ST-Link Utility software
- Aceinna Developer's login

1a – EVK Setup: Hardware setup

Setup Evaluation Board – runs the default RTK INS application

1. Plug in power adapter
2. Connect EVK to PC with micro USB cable
3. Connect GNSS antenna cable to EVK
4. Check the LEDs for working status
 - a. YELLOW: flashing light indicates GNSS chipset is powered on with a valid 1PPS signal
 - b. GREEN: flashing light indicates OpenRTK330 INS App is running correctly and receiving a valid GNSS signal from the antenna
 - c. RED: receiving valid GNSS base station corrections data
 - i. This will be valid after configuring your OpenARC/RTK account, and connectivity to the module.



1b – EVK Setup: Data Visualization

1. Open Aceinna Navigation Studio web GUI:
<https://developers.Aceinna.com/devices/rtk>
2. Start the python driver executable
 - a. Run “ans-devices.exe” from a command line or Windows.
 - i. The Python driver establishes connection with the ANS via USB.
 - b. If successful, a “WS Server connected” notification appears and the “Play” button is highlighted on OpenRTK Monitor.
3. Click “PLAY” on the OpenRTK monitor for visualization
 - a. A live map shows the position and trajectory
 - b. Navigation panel shows PVA and RTK status information
 - c. Two panels for satellite information on SNR, azimuth, elevation angles, with a satellite Skyview Chart.
4. IMU data can also be viewed and logged

Note: The web GUI and OpenRTK Monitor is useful for first time users to verify that the evaluation kit is configured and working as expected. For advanced evaluation and development tools, refer to Developer’s Environment.

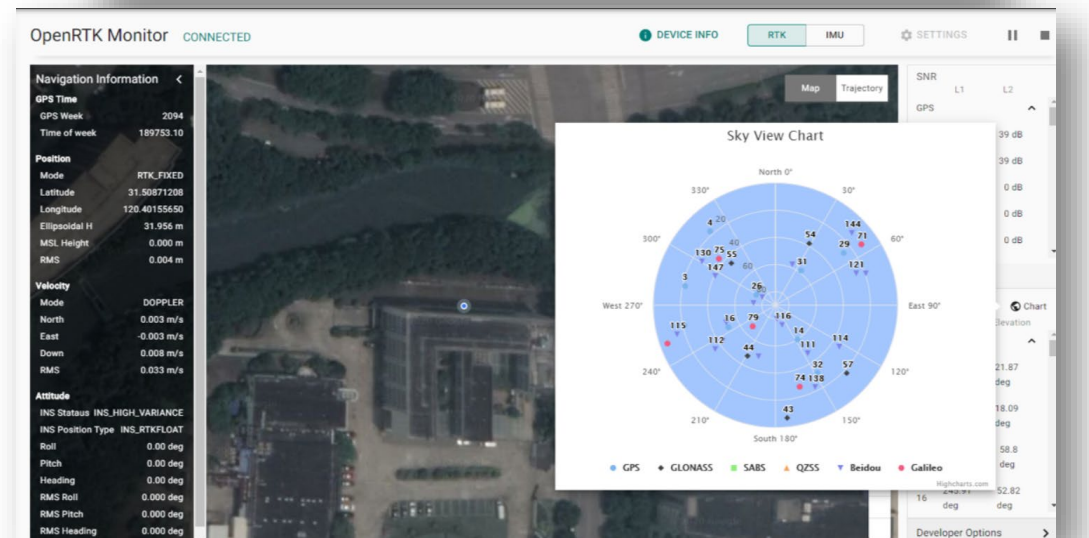
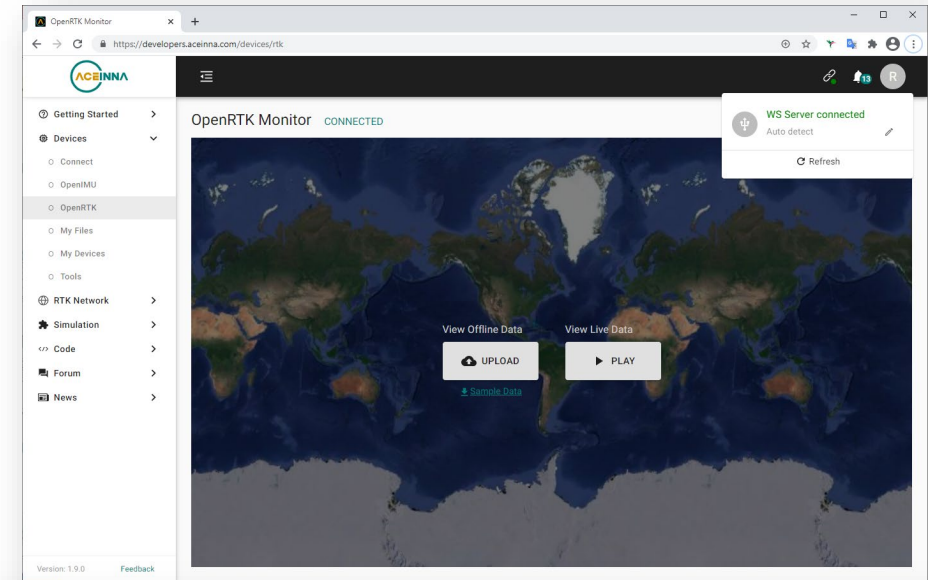

1c – EVK Setup: Connectivity for OpenRTK330

Option 1: Ethernet with router & modem

1. Connect an Ethernet cable between the RJ45 jack on the EVB and a router/switch
 - a. The router is connected to a modem; in some cases EVB may connect directly to a modem.
2. Connect the router/switch to your PC.
3. The OpenRTK330 gets assigned an IP address in the local network via DHCP.
4. Open OpenRTK330's embedded web interface <http://openrtk> in a browser
5. Select "Ethernet configuration", IP address of OpenRTK330 is shown if DHCP is chosen.
6. Configure a static IP by selecting from the "Mode" drop down menu and entering static IP information.
7. Click SAVE to store the changes.

Option 2: Ethernet from PC TCP/IPv4

1. Connect an Ethernet cable directly between the PC and EVB.
2. Configure network settings on your PC and share network – see [Appendix 1](#).



Aceinna OpenRTK	
MENU	Ethernet Configuration
Running Status	Summary
Work Configuration	DHCP: ON
INS Configuration	IP Address: 192.168.1.101
Can Configuration	Netmask: 255.255.255.0
User Configuration	Gateway: 192.168.1.1
	MAC: 02:00:00:4F:00:2E
Ethernet Configuration	Configure
Device Info	MODE: <input type="text" value="DHCP"/>
	STATIC IP: <input type="text" value="192.168.137.110"/>
	STATIC NETMASK: <input type="text" value="255.255.255.0"/>
	STATIC GATEWAY: <input type="text" value="192.168.137.1"/>
	<input type="button" value="SAVE"/>

1d – EVK Setup: Configuring OpenRTK330 with OpenARC

1. Access OpenRTK330's embedded web interface for RTK/NTRIP user configuration
 - a. Open <http://openrtk> in a browser
2. Select “Work Configuration”, then “ROVER”, then select the “Aceinna Client” tab
3. Fill in the following NTRIP settings* and click “ENABLE” to save settings and start receiving GNSS corrections

- IP: openarc.aceinna.com
- PORT: 8011
- Mount Point: RTK
- User Name: *sendmedata*
- Password: *youbet*

* From [OpenARC account settings](#) or standard NTRIP credentials

4. The running status should read RTK Fixed/Float and the red LED on the EVB should be flashing
5. Click “INS Configuration” to configure INS related parameters such as Lever Arms for field drive tests

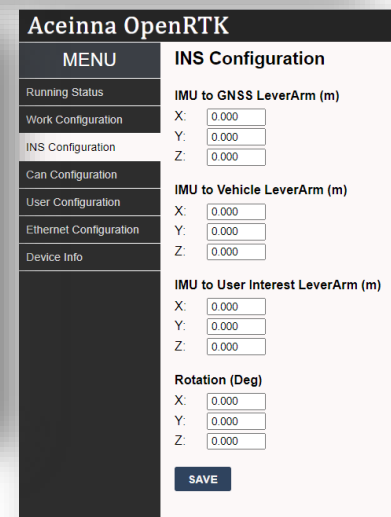
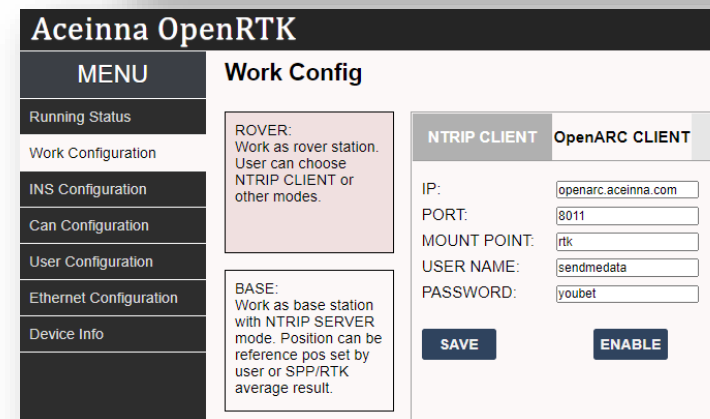
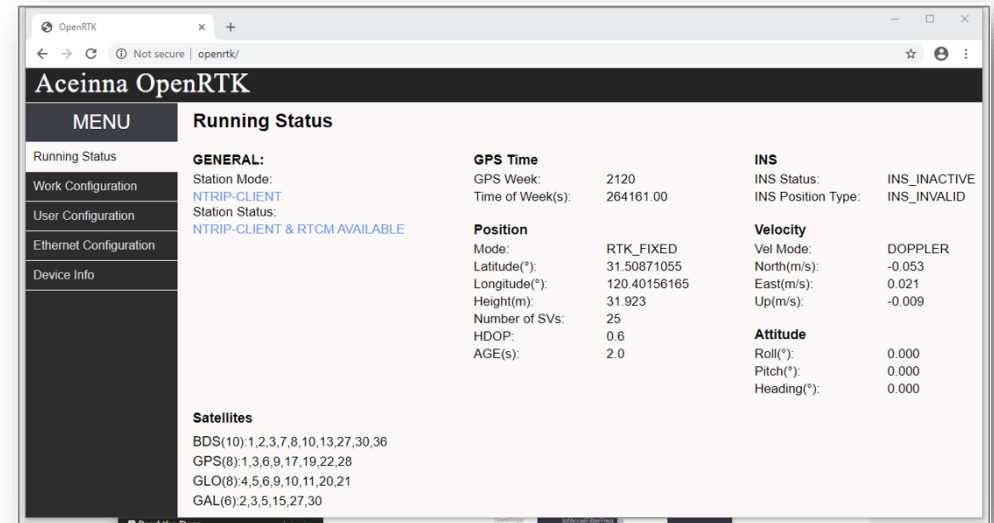

1e – EVK Setup: Connecting via Android App

Using the Android mobile app allows the user to connect to OpenRTK330 via Bluetooth to provide cellular internet. The user can visualize location & trajectory on the app, and enable data logging to.

1. Install Android App with detailed instructions in the [link](#) provided.
2. Connect EVK to PC with micro USB cable & Plug in power adapter.
3. Connect GNSS antenna cable to EVK.
4. Make sure Bluetooth is enabled on your mobile device. 🔍
5. In the “OpenRTK” app, select “Connect” tab and click the “search” icon. Select the EVK to connect.
6. Go to “NTRIP” tab and configure the NTRIP server with your OpenARC account settings. Click “SAVE”.
7. Switch on “Pull Base” to get GNSS correction data.
8. Go to “Map” tab, click “Start Live Data” to view real time positioning information and trajectory.
9. On Home menu, go to user configuration by clicking the icon “≡” at the upper left corner.
10. Click “Developer Option” to configure the map presentation and saving positioning results (NMEA GGA messages only) to Android phone storage.
 - a. The default storage path is “Android/data/com.aceinna.rtk/files/log”

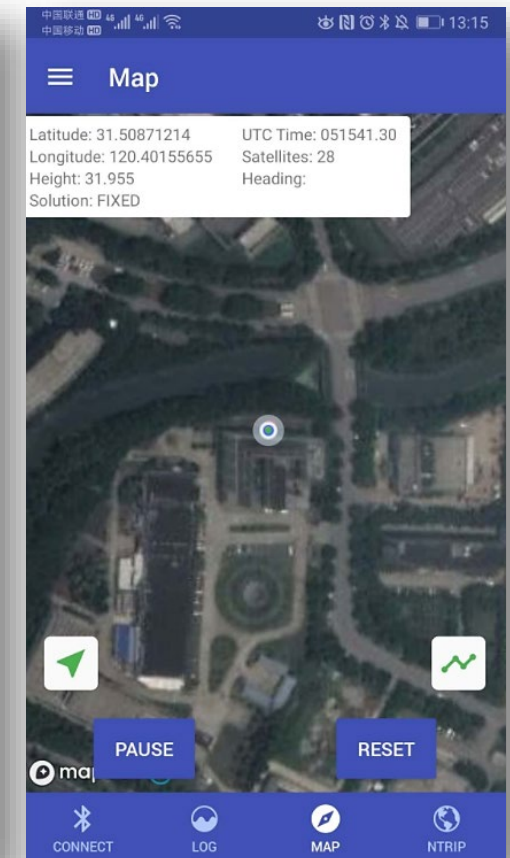
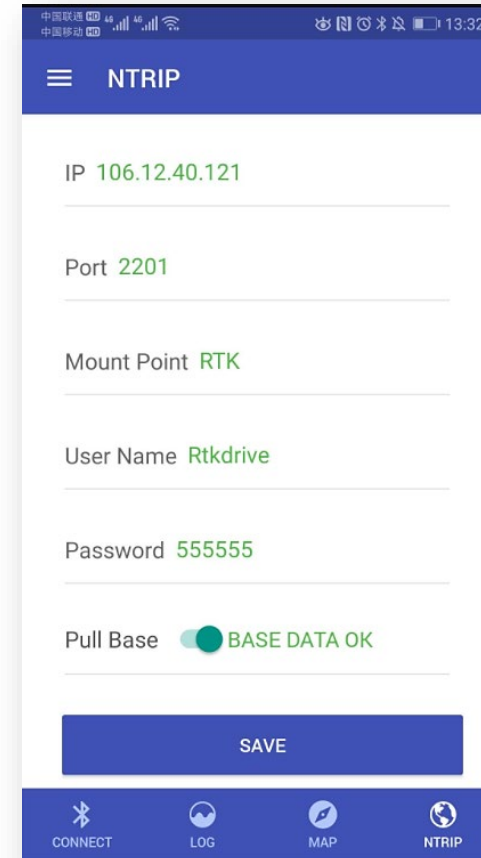

1f – EVK Setup: Data Logging & Parsing

1. Log data

- Running the Python driver automatically logs all UART output from OpenRTK330 module.
- A “data” folder is created inside the Python driver folder and a “log file” folder is created inside the “data” folder.
- Each “log file” folder includes the following files:
 - Configuration.txt – Parameter Settings of current module
 - User_<time>.bin – User com port Output
 - Debug_<time>.bin – Debug com port Output

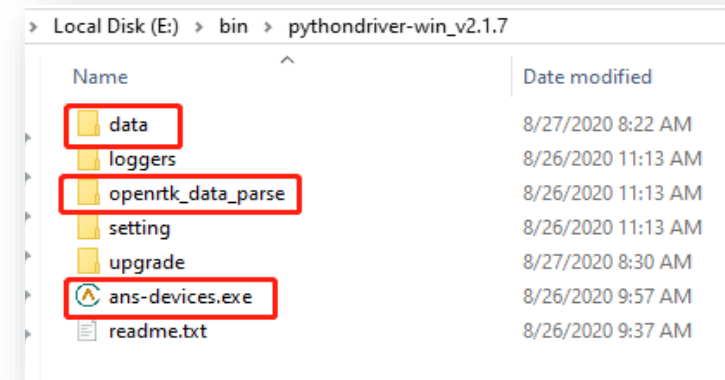

2. Parse Data

- Run the OpenRTK data decoder executable inside the parser folder to parse the logged OpenRTK330 binary files.
 - cd C:\pythondriver-win\openrtk_data_parse
 - .\openrtk_parse.exe -p ..\data\openrtk_log_20200827_082236
- The logged bin files from OpenRTK serial ports are parsed into csv files for post-processing and analysis.
- The content of each “csv” file is described in its file header.

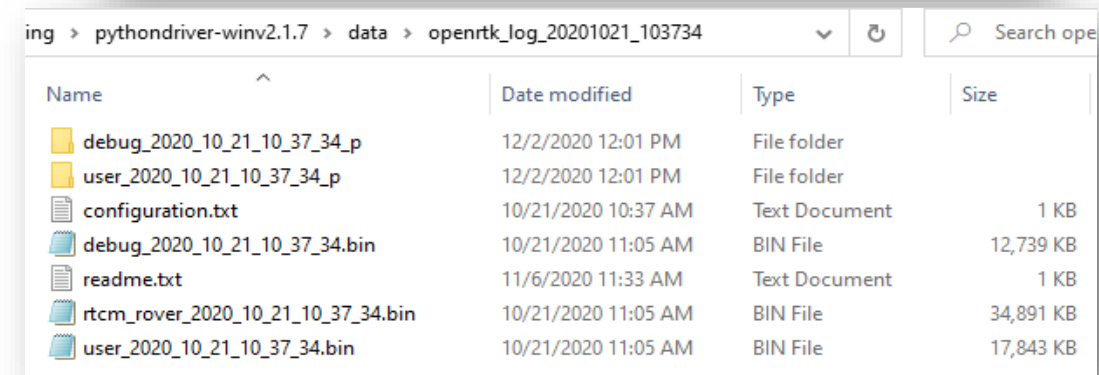
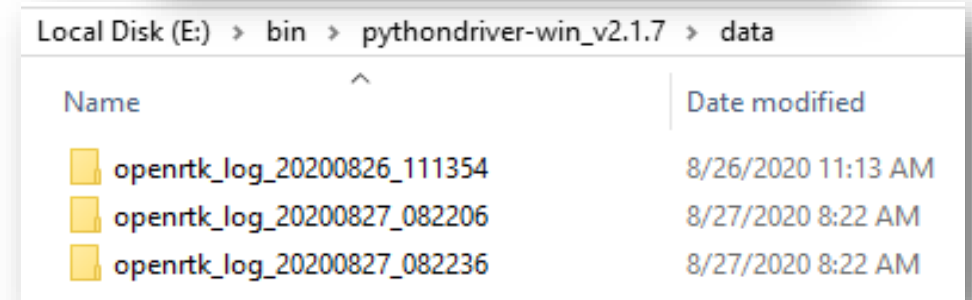

2 – Vehicle Installation

1. To install the OpenRTK330 EVB on a vehicle for a drive test, reference frames must be defined. See Appendix 2.
2. The user has to configure two offsets or lever arms for the integrated INS solution to work properly, based on installation orientation in the vehicle.
3. These offsets need to be applied/updated in [INS configuration settings](#) in the OpenRTK330 embedded web interface.
4. Translation offset:
 - a. GNSS antenna lever-arm:
 - GNSS position is estimated to the phase center of the GNSS antenna, and INS position is estimated to the center of the navigation of the IMU.
 - The translation from the IMU center to the phase center of the GNSS antenna has to be known and applied to the integrated system via user configuration of the antenna lever-arm.
 - The GNSS/INS integrated solution outputs position at the IMU center.
 - b. User output lever-arm:
 - If user wants the GNSS/INS integrated solution output at a more useful position, the translation between the IMU center and the designated point of interest has to be known and applied via INS configuration of point of interest lever-arm.
5. Rotation offset:
 - a. This compensates for rotation if the axes of the IMU body frame of the installed OpenRTK330 unit is not aligned with the vehicle frame.
 - b. The orientation of the IMU relative to the vehicle must be known and applied via INS configuration
 - c. More information and an example is available in the [Online manual](#).

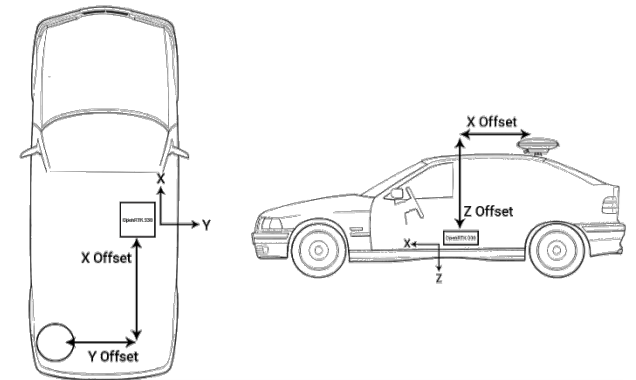

Aceinna OpenRTK	
MENU	INS Configuration
Running Status	IMU to GNSS LeverArm (m)
Work Configuration	X: <input type="text" value="0.000"/>
INS Configuration	Y: <input type="text" value="0.000"/>
Can Configuration	Z: <input type="text" value="0.000"/>
User Configuration	IMU to Vehicle LeverArm (m)
Ethernet Configuration	X: <input type="text" value="0.000"/>
Device Info	Y: <input type="text" value="0.000"/>
	Z: <input type="text" value="0.000"/>
	IMU to User Interest LeverArm (m)
	X: <input type="text" value="0.000"/>
	Y: <input type="text" value="0.000"/>
	Z: <input type="text" value="0.000"/>
	Rotation (Deg)
	X: <input type="text" value="0.000"/>
	Y: <input type="text" value="0.000"/>
	Z: <input type="text" value="0.000"/>
	SAVE

3 – Backup System Image for Recovery

It is highly recommended to save the OpenRTK330 module's factory system image to a binary file for recovery in case of a system error. The OpenRTK330 will not work properly if the system bootloader or IMU calibration tables are accidentally corrupted.

1. Save System Image

- Connect ST-Link debugger between OpenRTK330 EVB and PC via JTAG and USB. Power up the EVB.
- Open ST-Link Utility software on the PC. Select Target → Connect.
- Enter value **0x08000000** in Address box and **0x100000** in Size box (see image). Hit Enter.
- Click File → Save As to save the system image file.

2. Recover System Image

- Connect ST-Link debugger between OpenRTK330 EVB and PC via JTAG and USB. Power up the EVB.
- Open ST-Link Utility software on the PC. Select Target → Connect.
- Click File → Open and select the previously saved image file.
- Click Target → Program & Verify. Make sure the Start Address is **0x08000000**.
- Select the Start button to begin re-programming the OpenRTK330 module.
- Once it is complete, it shows “Successfully Completed”
- Enable Write Protection: Click Target → Option Bytes, select “Sector 0”, “Sector 1”, “Sector 2”, “Sector 3” “Sector 11”. Apply.

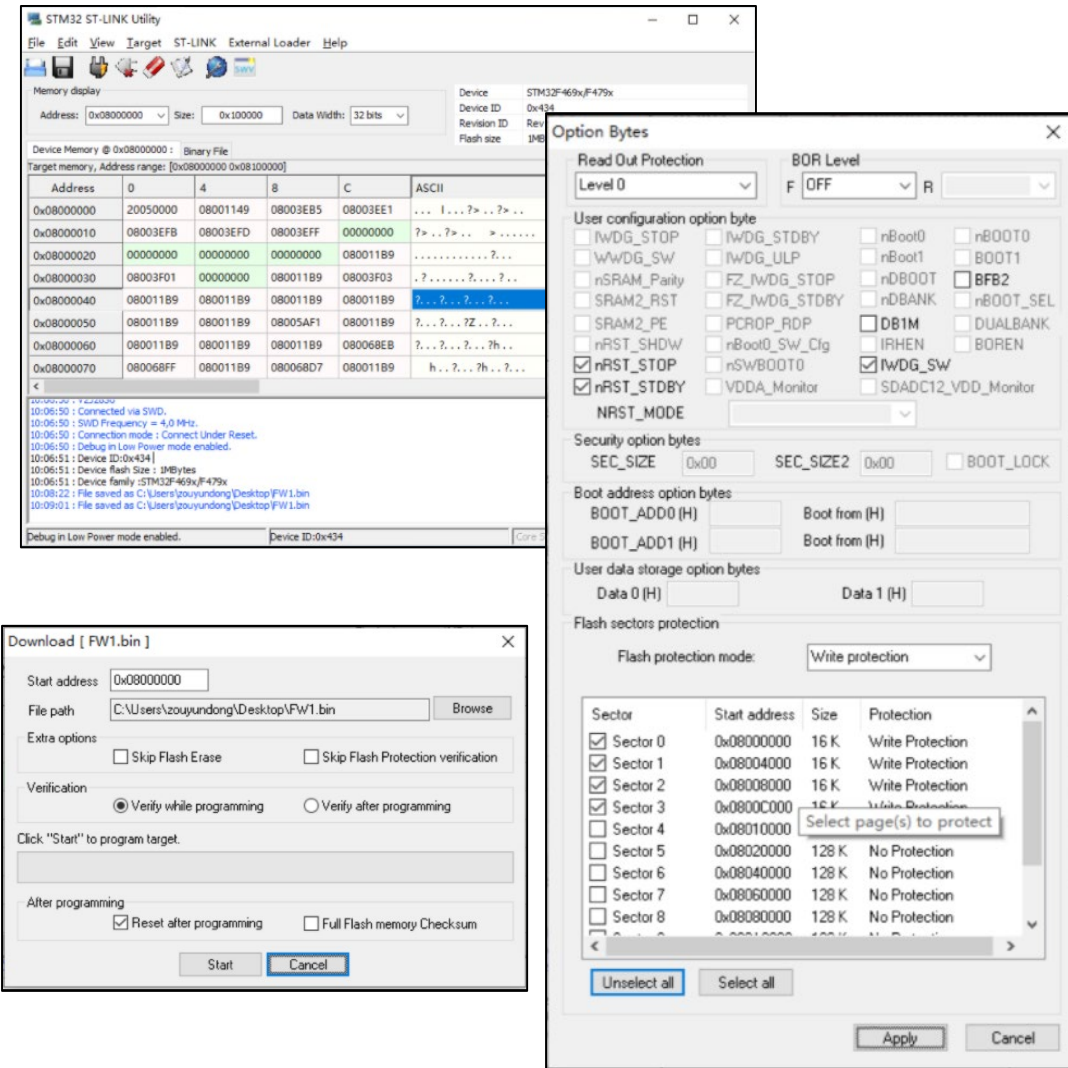

4 – Upgrading Firmware

Firmware and bootloader updates are always available on the [ANS App](#) center under the Code menu.

1. Upgrade OpenRTK330LI bootloader

- a. Connect ST-LINK debugger between a PC and the EVB via JTAG and USB.
- b. Connect EVK to PC with micro USB cable, plug in power adapter.
- c. Download the latest Bootloader bin file from the App center.
- d. Open ST Utility, click Target → Connect, then Target → Program & Verify .
- e. Select the downloaded bootloader bin file when prompted.
- f. Check “Verify while programming” and “Reset after programming”, click “Start” button.
 - i. Disconnect the ST-LINK debugger when complete

2. Upgrade OpenRTK330LI firmware

- a. Connect EVK to PC with micro USB cable, the yellow LED will start flashing.
 - i. Run the latest Python driver executable “ans-devices.exe” from a command line or Windows.
- b. In the ANS App center, select the latest “GNSS_RTK_INS” App, and click “UPGRADE”.
 - i. The yellow LED will turn off and the green LED will flash quickly during the upgrade.
- c. A notification will appear upon completion.

The image displays a sequence of screenshots from the ANS App Center and ST Utility. The top screenshot shows the ANS App Center interface with a sidebar menu and a main area displaying various applications like DEMO, Bootloader, and GNSS_RTK_INS. The middle screenshot shows a detailed view of the 'OpenRTK330LI - GNSS_RTK_INS v2.0.0' application, including its update time and author information, with a prominent 'UPGRADE' button. The bottom screenshot is a dialog box for downloading the 'OpenRTK330LI_Bootloader_v1.1.1.bin' file, showing the start address (0x08000000), file path, and options for verification and programming.

Appendix 1 – Ethernet TCP/IPv4 Setup

You can provide connectivity to the OpenRTK330LI module on the EVK by connecting an Ethernet cable directly between the EVK and your PC, and configuring the network settings to enable sharing.

1. Go to Control Panel → Network and Internet Connections
 - a. An Ethernet subnetwork is established for the Ethernet connection between the EVB and the PC, e.g. “Ethernet 2”
2. Right-click “Ethernet 2”, and then click “Properties”, on the “Networking” tab
 - a. Select “Internet Protocol Version 4 (TCP/IPv4)”, configure the IP settings as follows:
 - b. The gateway has to be 192.168.137.1, and the subnet mask has to be 255.255.255.0,
 - c. The IP address can be assigned to one that has not been taken in the network 192.168.137.xx.
3. Right-click WLAN (assuming the PC uses WiFi for internet access)
 - a. Go to Properties → Sharing, check the “Allow other network users to connect through this computer’s internet connection”
 - b. Select “Ethernet 2” on the drop down menu below, click “OK” to enable the EVB to have access to internet shared by the PC.
4. Open OpenRTK330’s embedded web interface <http://openrtk> in a browser
5. Select “Ethernet Configuration”, change network mode from “DHCP” to “static”, the default IP address should be “192.168.137.110”
6. Click SAVE to store the changes and go into effect

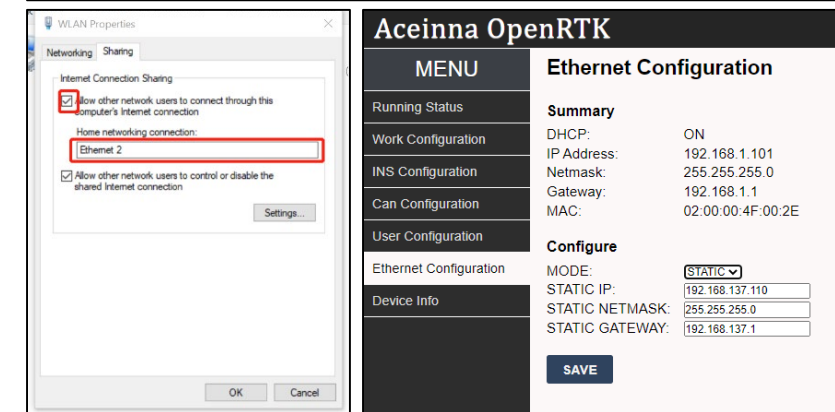
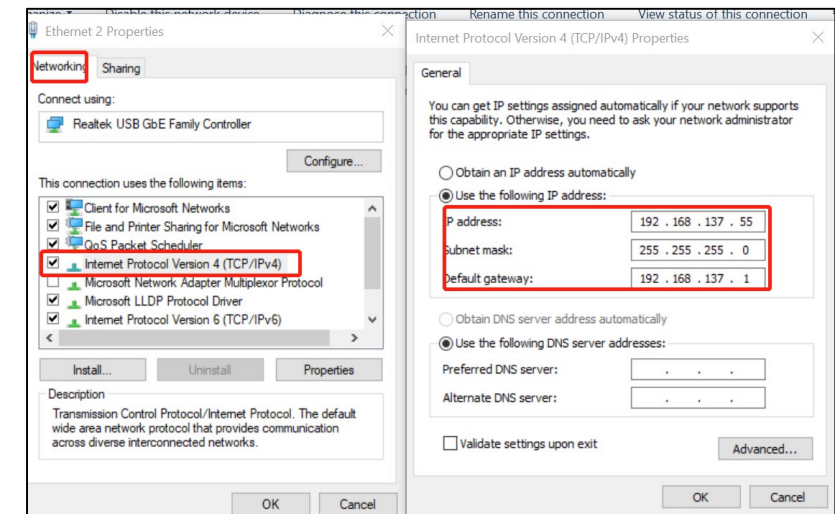
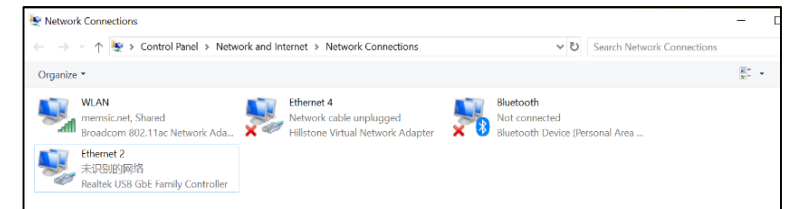

Appendix 2 – Reference Frames

By default, the INS solution of OpenRTK330 is referenced to the center of the IMU (refer to the mechanical drawing for accurate IMU center position on the EVB).

1. The IMU body frame is defined as shown in the figure.
 - a. x-axis: points to the same direction as the SMA antenna interface
 - b. z-axis: perpendicular to x-axis and points downward
 - c. y-axis: points to the side of the EVK and completes a right-handed coordinate system
2. The vehicle frame is defined as
 - a. x-axis: points out the front of the vehicle in the driving direction
 - b. z-axis: points down to the ground
 - c. y-axis: completes the right-handed system
3. The local level navigation frame is defined as
 - a. x-axis: points north
 - b. z-axis: points down parallel with local gravity
 - c. y-axis: points east
4. The user output frame is used to transfer the INS solution to a user designated position.

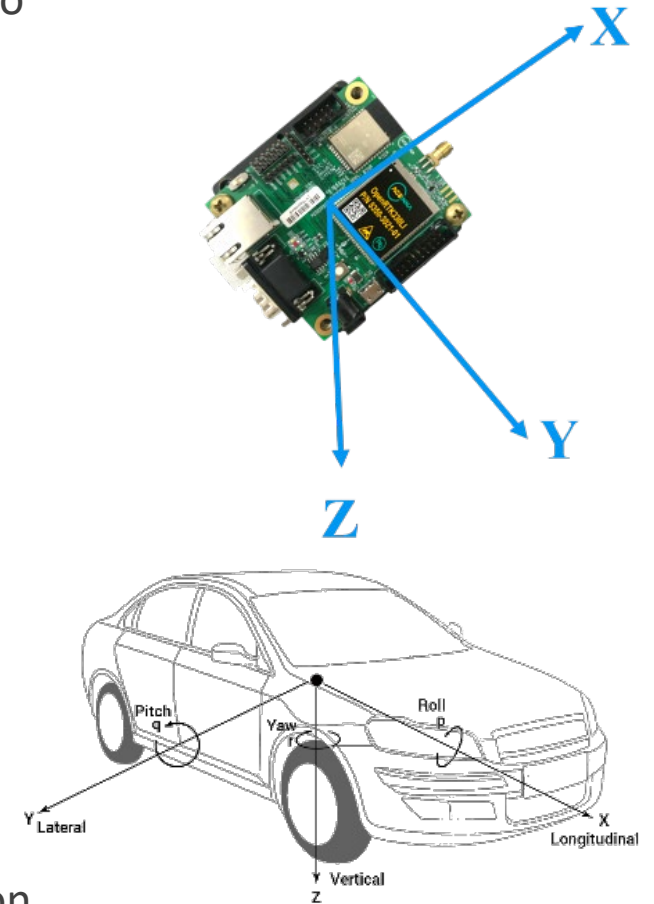

Developer's Environment – *under construction*